

# IMPLANTOLOGY

## IMPLANT PERIOSTEALS

Hand instrument, usually double ended, used to separate the periosteum from the underlying bone.



## IMPLANT PERIODONTAL CHISELS

Hand instrument used to remove hard tissues such as enamel or bone by chipping, cleaving or paring. The beveled blade may be in line with the handle or at an angle to it.

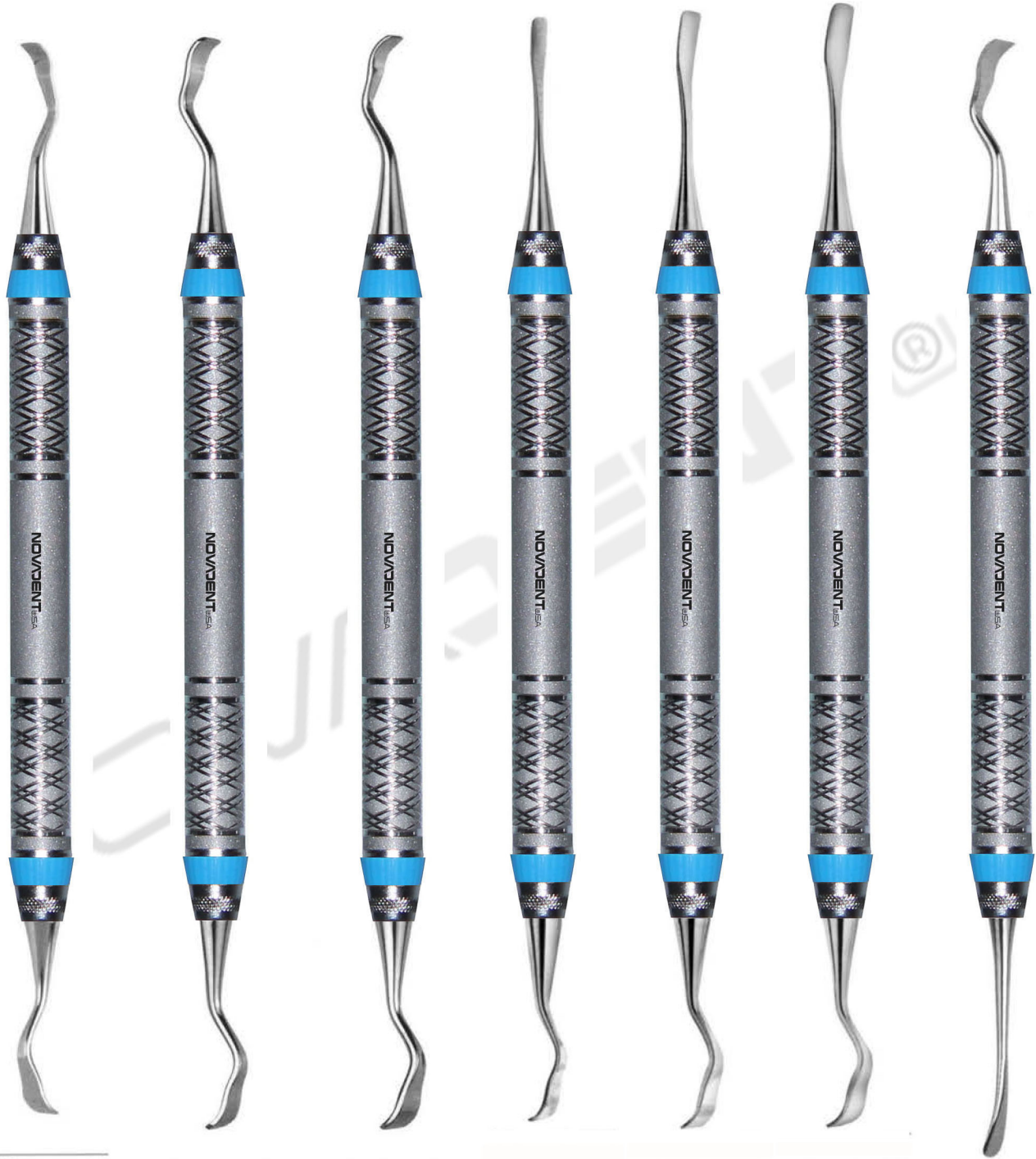

1/2  
Buser Modified  
Periodontal  
Chisel  
3mm/4mm

**IPCBM1/2**  
1970

2/3  
Buser Modified  
Periodontal  
Chisel  
4mm/5mm

**IPCBM2/3**  
1971

1/3  
Buser Modified  
Periodontal  
Chisel  
3mm/5mm

**IPCBM1/3**  
1972

Jovanovic  
13KTG  
Periodontal  
Chisel  
1mm/4mm

**IPCJOV1/4**  
1973

Jovanovic  
13KTG  
Periodontal  
Chisel  
2mm/5mm

**IPCJOV2/5**  
1974

Jovanovic  
13KTG  
Periodontal  
Chisel  
3mm/6mm

**IPCJOV3/6**  
1975

P24G/13KL  
Palacci Modified

**IPC24G/13KL**  
1976



# IMPLANTOLOGY

## BONE SCOPE / BONE PLUGGERS

**Bone Scoops:** Hand instrument similar to a bone chisel but having a hollowed-out blade similar to coupland chisel.

**Bone Plugger:** Used to plug and condense grafted bone.

### BONE SCOOPS



Jovaanovic  
None Scoop  
5mm

**IBSJOV5mm**  
2020

Bone Graft  
Scoop

**IBSBG**  
2021

Labanca  
Bone Curette  
7mm

**ICLBC**  
2022

### BONE PLUGGERS

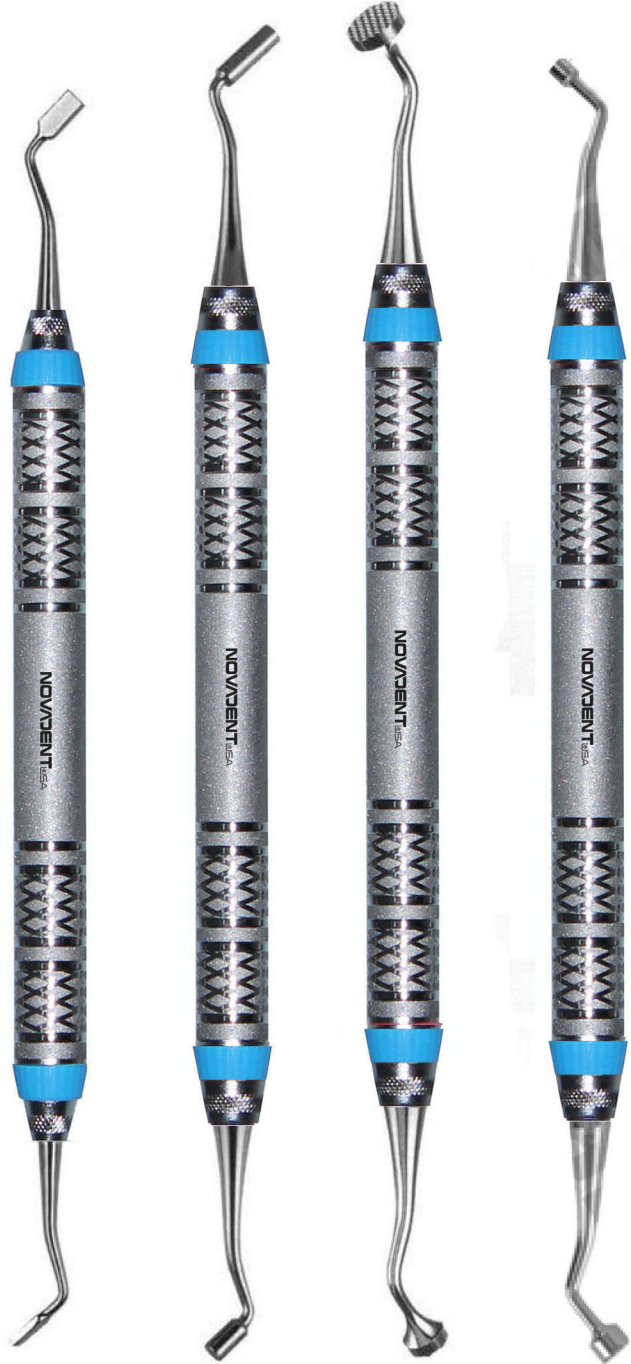

LaBanca  
3x1.5mm

**IBPLAB**  
2023

4  
Jovanovic  
3mm

**IBPJ4**  
2024

Bone  
Packer DE  
5-7mm

**IBPP5-7**  
2025

Bone Packer  
Serrated  
3-5mm

**IBPS3-5**  
2026

### Sinus Lift Instruments



Sinus Cobra 3.5mm

ISC3.5  
2052



Sinus Cobra In/Out

ISCI/O  
2053



Mushroom Sinus Lift  
(2-4-5-6-8-10)

IMSL2.8/3.8  
2054



Mushroom Sinus Lift  
(2-4-5-6-8-10)

IMSL4.8/5.8  
2055



## BONE GRAFTING INSTRUMENTS



Bone Graft (1.0-1.7mm)  
(8-11-13-15-18)  
IBG1.0/1.7  
2081  
**IBG1.0/1.7**  
2081



Bone Graft (1.7/2.0mm)  
(8-11-13-15-18)  
**IBG1.7/2.0**  
2082



Bone Graft (2.4/2.7mm)  
(8-11-13-15-18)  
**IBG2.4/2.7**  
2083



Bone Graft (3.3/4.0mm)  
(8-11-13-15-18)  
**IBG3.3/4.0**  
2084



Bone Graft (3.3/4.0mm)  
(8-11-13-15-18), Serrated  
**IBGS3.3/4.0**  
2085



TPI1-Tunneling Procedure Instrument

ITPI1  
2090



TPI2-Tunneling Procedure Instrument

ITPI2  
2091



TPI3-Tunneling Procedure Instrument

ITPI3  
2092



TPI4-Tunneling Procedure Instrument

ITPI4  
2093



ITPI5-Tunneling Procedure Instrument

ITPI5  
2094



TPI6-Tunneling Procedure Instrument

ITPI6  
2095



TPI7-Tunneling Procedure Instrument

ITPI7  
2096

## TUNNELING KNIVES



Urban Tunneling Knife

IUTK  
2097



Tunneling Knife 1

ITK1  
2098



Tunneling Knife 2 (Short Handle)

ITK2S  
2099



Tunneling Knife 2

ITK2  
2100



Giles De Quincey Knife 1

IGDQK1  
2101



Giles De Quincey Knife 2

IGDQK2  
2102



Steigmann Soft Tissue Splitter

ISSTS  
2103



Steigmann Soft Tissue Splitter, Modified

ISSTSM  
2104



**Osteotome Chisels:** Surgical instruments used to cut or divide bone.



Osteotome Chisel  
Straight, Single Edge  
4mm

**IOCSSE4**

2 1 1 0



Osteotome Chisel  
Curved, Single Edge  
4mm

**IOCCSE4**

2 1 1 1



Osteotome Chisel  
Straight, Single Edge  
7.5mm

**IOCSSE 7.5**

2 1 1 2



Osteotome Chisel  
Curved, Single Edge  
7.5mm

**IOCCSE 7.5**

2 1 1 3



Osteotome Chisel  
Jovanovic  
6mm

**IOCJOV6**

2 1 1 4

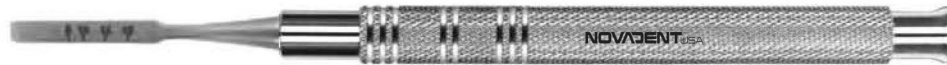

Osteotome Chisel  
Single Edge  
3mm

**IOCSE3**

2 1 1 5

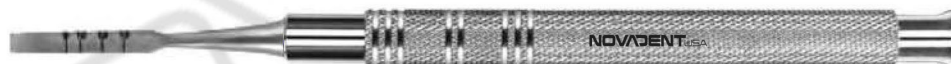

Osteotome Chisel  
Double Edge  
3mm

**IOCDE3**

2 1 1 6

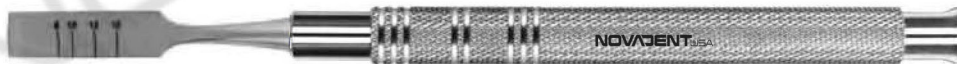

Osteotome Chisel  
7-10-13-15-18mm  
Single Edge, 6mm

**IOCSE6**

2 1 1 7

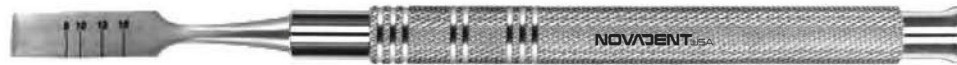

Osteotome Chisel  
7-10-13-15-18mm  
Double Edge, 6mm

**IOCDE6**

2 1 1 8

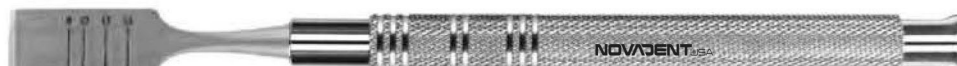

Osteotome Chisel  
7-10-13-15-18mm  
Single Edge, 9mm

**IOCSE9**

2 1 1 9

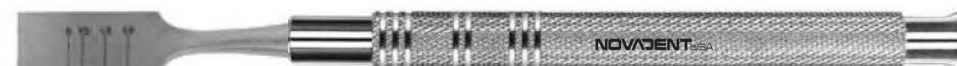

Osteotome Chisel  
7-10-13-15-18mm  
Double Edge, 9mm

**IOCDE9**

2 1 2 0

Martensite stainless steel tissue punches.



Tissue  
Punch STR  
4mm  
**ITPS4**  
2 130



Tissue  
Punch STR  
5mm  
**ITPS5**  
2 131



Tissue  
Punch STR  
6mm  
**ITPS6**  
2 132



Tissue  
Punch CVD  
2mm  
**ITPC2**  
2 133



Tissue  
Punch CVD  
3mm  
**ITPC3**  
2 134



Tissue  
Punch CVD  
4mm  
**ITPC4**  
2 135



Tissue  
Punch CVD  
5mm  
**ITPC5**  
2 136



Tissue  
Punch CVD  
6mm  
**ITPC6**  
2 137

## SINUS LIFT INSTRUMENTS



1  
MILLS SINUS  
IMS1  
2 2 3 0



2  
MILLS SINUS  
IMS2  
2 2 3 1



3  
MILLS SINUS  
IMS3  
2 2 3 2



1  
PIKOS SINUS  
IPS1  
2 2 3 3



2  
PIKOS SINUS  
IPS2  
2 2 3 4



3  
PIKOS SINUS  
IPS3  
2 2 3 5



# IMPLANTOLOGY

## SINUS LIFT INSTRUMENTS

Designed to separate the sinus lining from the bone without fraying or tearing.



Designed to separate the sinus lining from the bone without fraying or tearing.

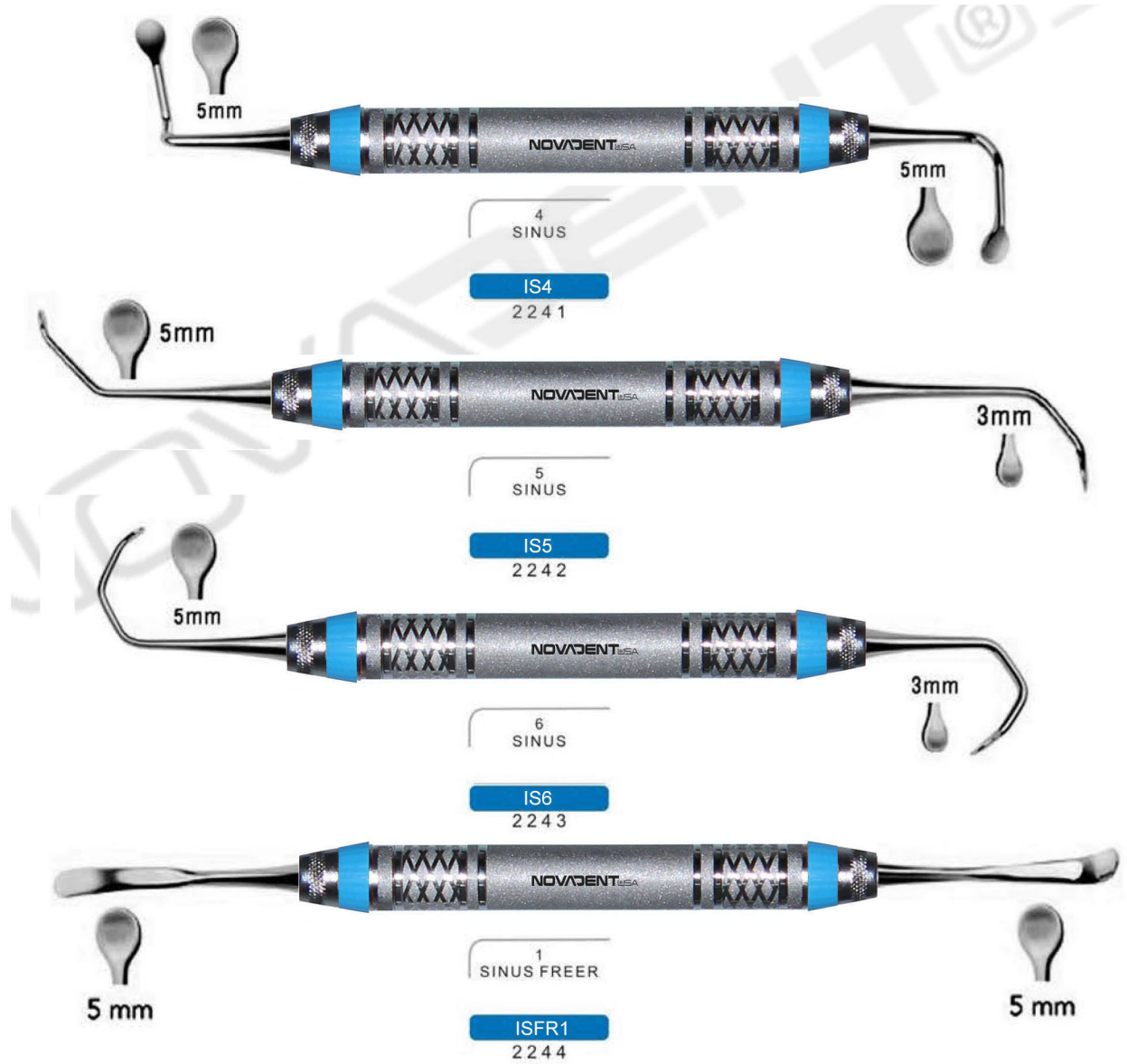

Designed to separate the sinus lining from the bone without fraying or tearing.

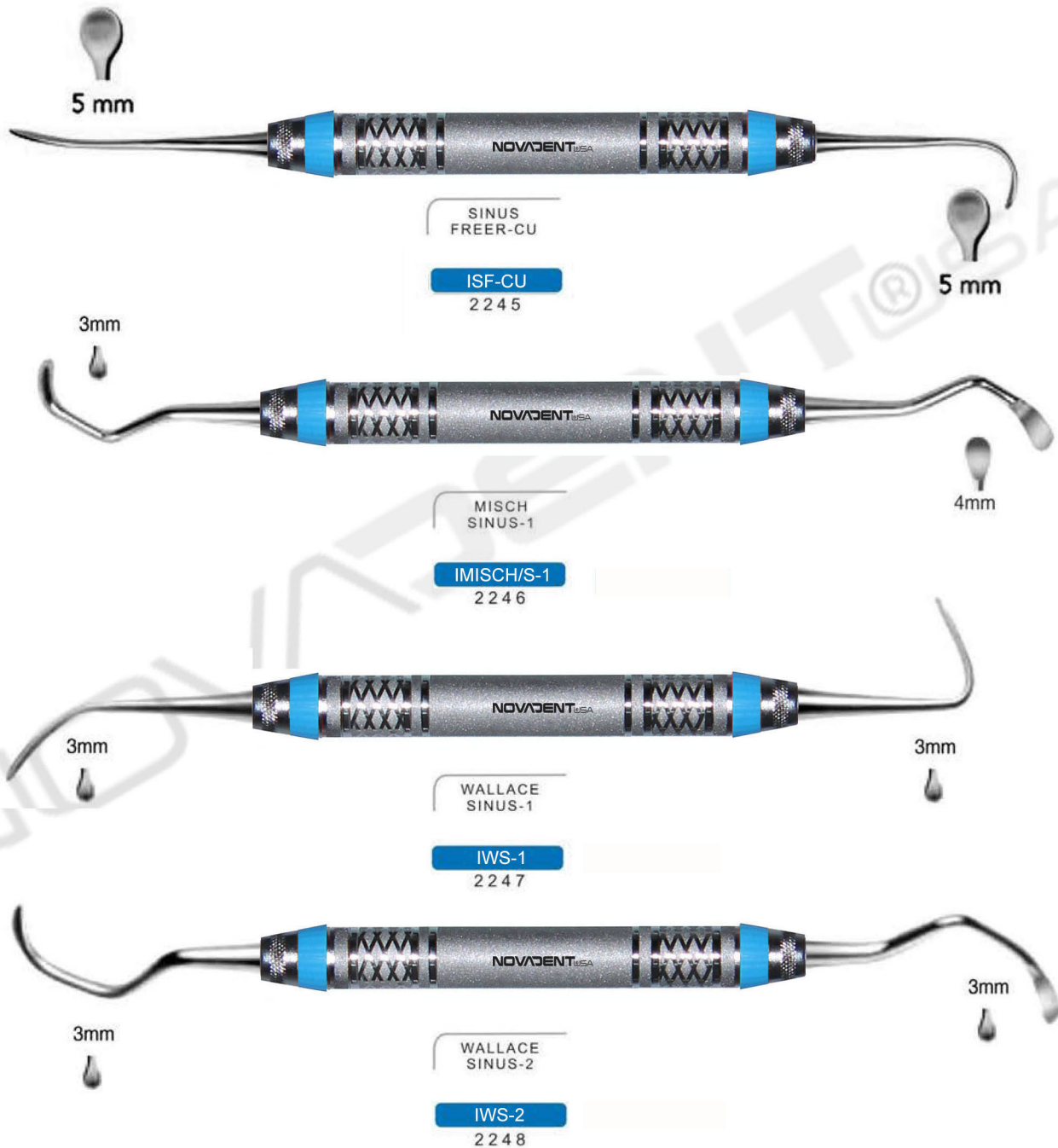



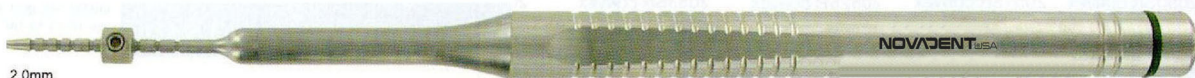

2.0mm  
**ITCCSO2.0**  
2255

Tapered Concave Tip-Straight - 2.0mm (4-6-8-10-13-16-18-20-23-26)

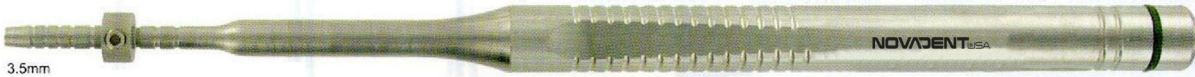

3.5mm  
**ITCCSO3.5**  
2256

Tapered Concave Tip-Straight - 3.5mm (4-6-8-10-13-16-18-20-23-26)

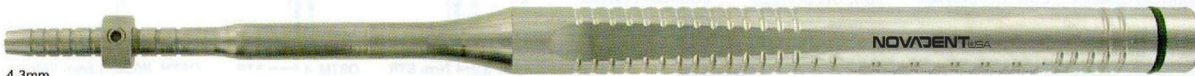

4.3mm  
**ITCCSO4.3**  
2257

Tapered Concave Tip-Straight - 4.3mm (4-6-8-10-13-16-18-20-23-26)

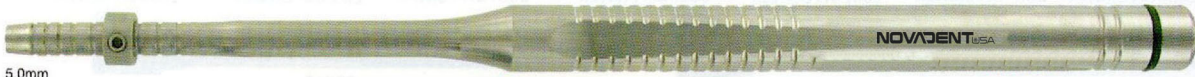

5.0mm  
**ITCCSO5.0**  
2258

Tapered Concave Tip-Straight - 5.0mm (4-6-8-10-13-16-18-20-23-26)

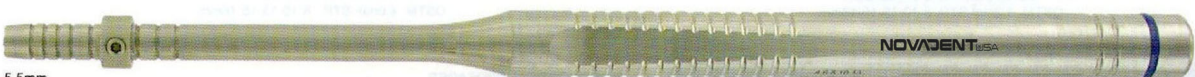

5.5mm  
**ITCCSO5.5**  
2259

Tapered Concave Tip-Straight - 5.5mm (4-6-8-10-13-16-18-20-23-26)



2.0mm  
**ITCCA02.0**  
2260

Tapered Concave Tip-Angulated - 2.0mm (4-6-8-10-13-16-18-20-23-26)

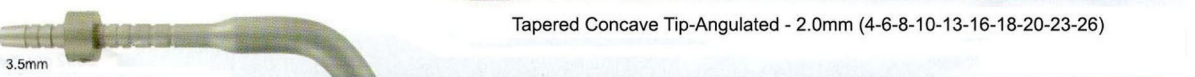

3.5mm  
**ITCCA03.5**  
2261

Tapered Concave Tip-Angulated - 3.5mm (4-6-8-10-13-16-18-20-23-26)

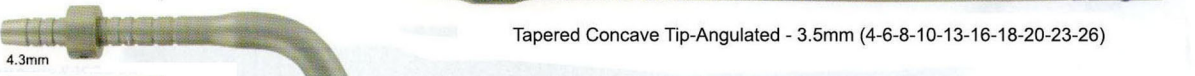

4.3mm  
**ITCCA04.3**  
2262

Tapered Concave Tip-Angulated - 4.3mm (4-6-8-10-13-16-18-20-23-26)

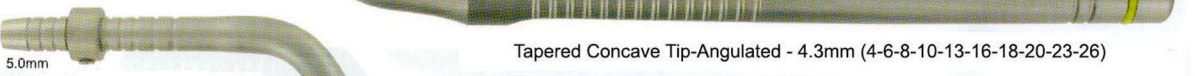

5.0mm  
**ITCCA05.0**  
2263

Tapered Concave Tip-Angulated - 5.0mm (4-6-8-10-13-16-18-20-23-26)

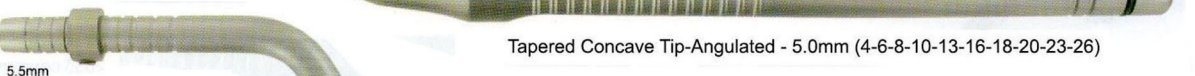

5.5mm  
**ITCCA05.5**  
2264

Tapered Concave Tip-Angulated - 5.5mm (4-6-8-10-13-16-18-20-23-26)





2.0mm  
**ITCVSO2.0**  
2270

Tapered Convex- Tip-Straight - 2.0mm (4-6-8-10-13-16-18-20-23-26)

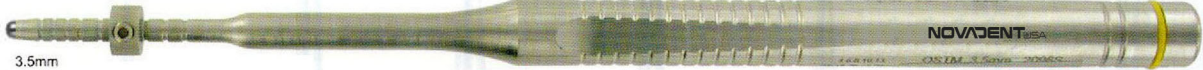

3.5mm  
**ITCVSO3.5**  
2271

Tapered Convex- Tip-Straight - 3.5mm (4-6-8-10-13-16-18-20-23-26)

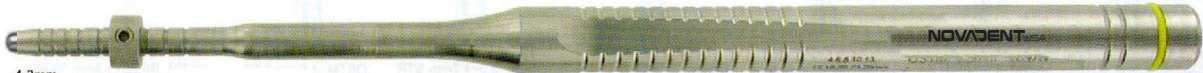

4.3mm  
**ITCVSO4.3**  
2272

Tapered Convex- Tip-Straight - 4.3mm (4-6-8-10-13-16-18-20-23-26)

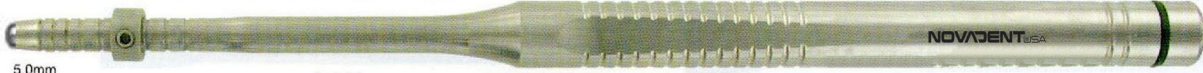

5.0mm  
**ITCVSO5.0**  
2273

Tapered Convex- Tip-Straight - 5.0mm (4-6-8-10-13-16-18-20-23-26)

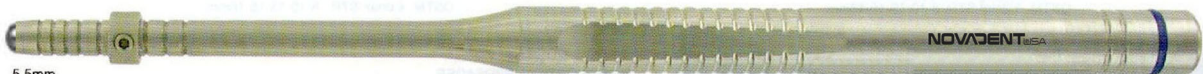

5.5mm  
**ITCVSO5.5**  
2274

Tapered Convex- Tip-Straight - 5.5mm (4-6-8-10-13-16-18-20-23-26)

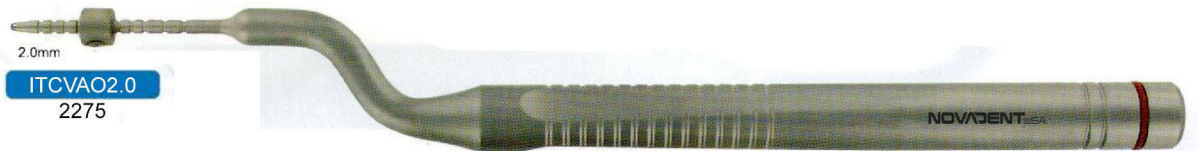

2.0mm  
**ITCVAO2.0**  
2275

Tapered Convex-Angulated Tip - 2.0mm (4-6-8-10-13-16-18-20-23-26)

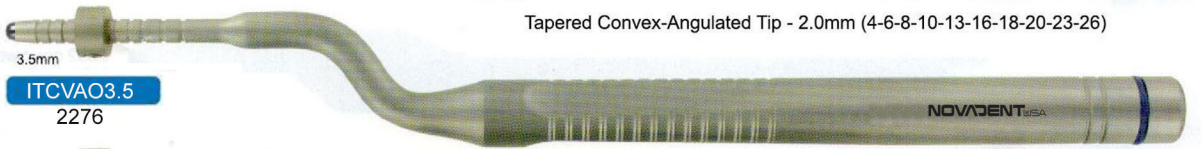

3.5mm  
**ITCVAO3.5**  
2276

Tapered Convex-Angulated Tip - 3.5mm (4-6-8-10-13-16-18-20-23-26)



4.3mm  
**ITCVAO4.3**  
2277

Tapered Convex-Angulated Tip - 4.3mm (4-6-8-10-13-16-18-20-23-26)

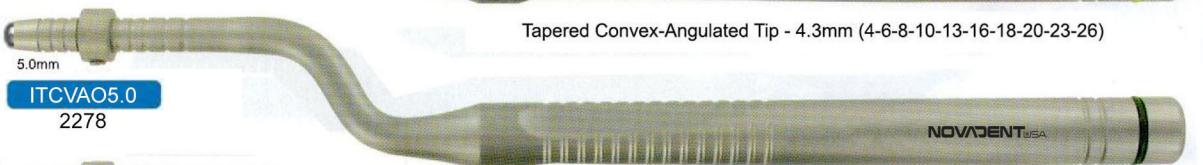

5.0mm  
**ITCVAO5.0**  
2278

Tapered Convex-Angulated Tip - 5.0mm (4-6-8-10-13-16-18-20-23-26)

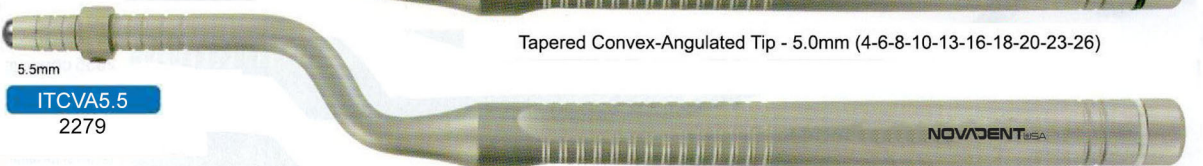

5.5mm  
**ITCVA5.5**  
2279

Tapered Convex-Angulated Tip - 5.5mm (4-6-8-10-13-16-18-20-23-26)



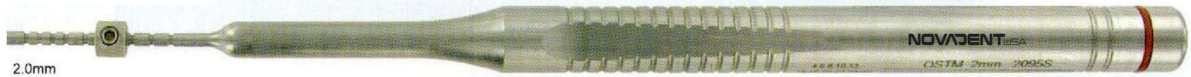

2.0mm

**IPSO2.0**

2281

PUSHER - Tip-Straight - 2.0mm (4-6-8-10-13-16-18-20-23-26)

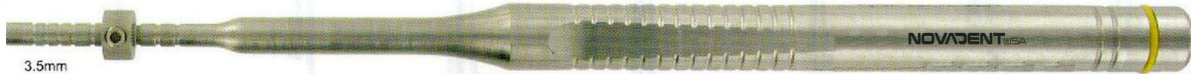

3.5mm

**IPSO3.5**

2282

PUSHER Tip-Straight - 3.5mm (4-6-8-10-13-16-18-20-23-26)

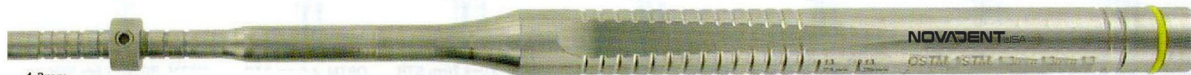

4.3mm

**IPSO4.3**

2283

PUSHER- Tip-Straight - 4.3mm (4-6-8-10-13-16-18-20-23-26)



5.0mm

**IPSO5.0**

2284

PUSHER- Tip-Straight - 5.0mm (4-6-8-10-13-16-18-20-23-26)



5.5mm

**IPSO5.5**

2285

PUSHER- Tip-Straight - 5.5mm (4-6-8-10-13-16-18-20-23-26)



2.0mm

**IPA02.0**

2286

PUSHER- Angulated Tip - 2.0mm (4-6-8-10-13-16-18-20-23-26)

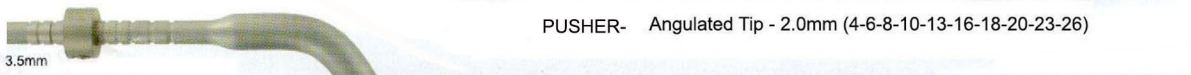

3.5mm

**IPA03.5**

2287

PUSHER- Angulated Tip - 3.5mm (4-6-8-10-13-16-18-20-23-26)

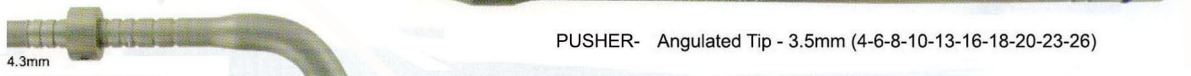

4.3mm

**IPA04.3**

2288

PUSHER- Angulated Tip - 4.3mm (4-6-8-10-13-16-18-20-23-26)

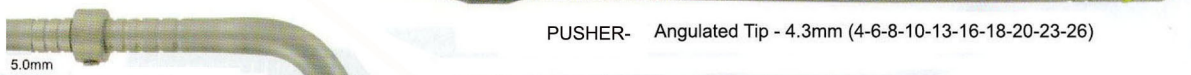

5.0mm

**IPA05.0**

2289

PUSHER- Angulated Tip - 5.0mm (4-6-8-10-13-16-18-20-23-26)

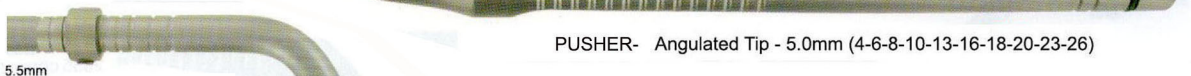

5.5mm

**IPA05.5**

2290

PUSHER- Angulated Tip - 5.5mm (4-6-8-10-13-16-18-20-23-26)



# IMPLANTOLOGY

## BONE SPREADING KIT

Bone Spreading  
Ostetome Kit



Interchangeable  
Osteotome Handle

## TAPERED CONVEX OSTETOMES

### STRAIGHT

2.7 mm    3.2 mm    3.7 mm    4.2 mm    5.0 mm



### ANGLED

2.7 mm    3.2 mm    3.7 mm    4.2 mm    5.0 mm



ICVOS2.7 2300    ICVOS3.2 2301    ICVOS3.7 2302    ICVOS4.2 2303    ICVOS5.0 2304

ICVOA2.7 2305    ICVOA3.2 2306    ICVOA3.7 2307    ICVOA4.2 2308    ICVOA5.0 2309

## BONE SPREADING KIT

### TAPERED CONCAVE OSTEOTOMES

#### STRAIGHT

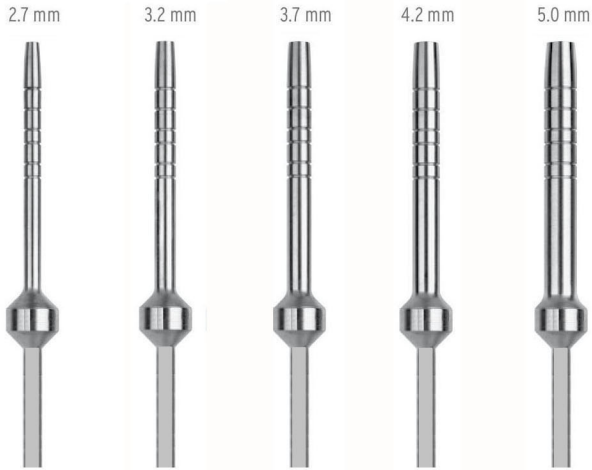

ICCOS2.7 2310   ICCOS3.2 2311   ICCOS3.7 2312   ICCOS4.2 2313   ICCOS5.0 2314

#### ANGLED

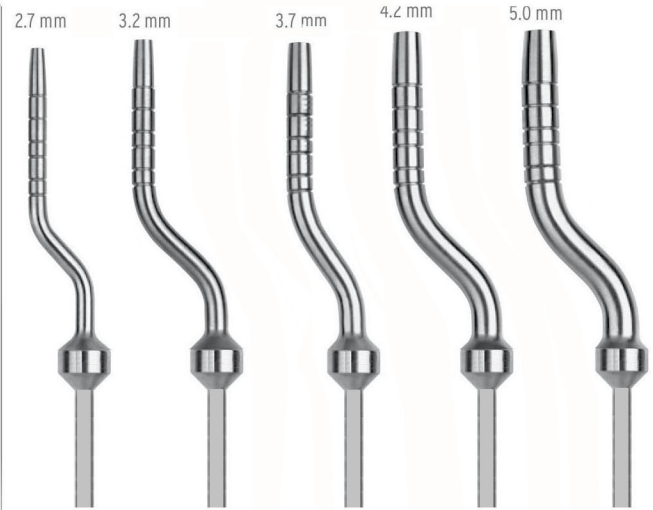

ICCOA2.7 2315   ICCOA3.2 2316   ICCOA3.7 2317   ICCOA4.2 2318   ICCOA5.0 2319

### BONE PUSHER OSTEOTOMES

#### STRAIGHT

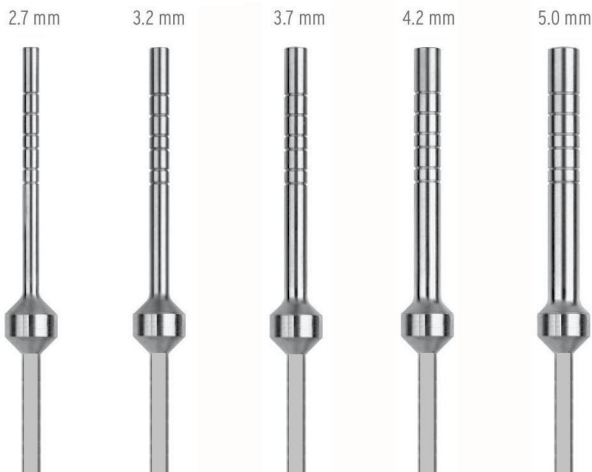

IPOS2.7 2320   IPOS3.2 2321   IPOS3.7 2322   IPOS4.2 2323   IPOS5.0 2324

#### ANGLED

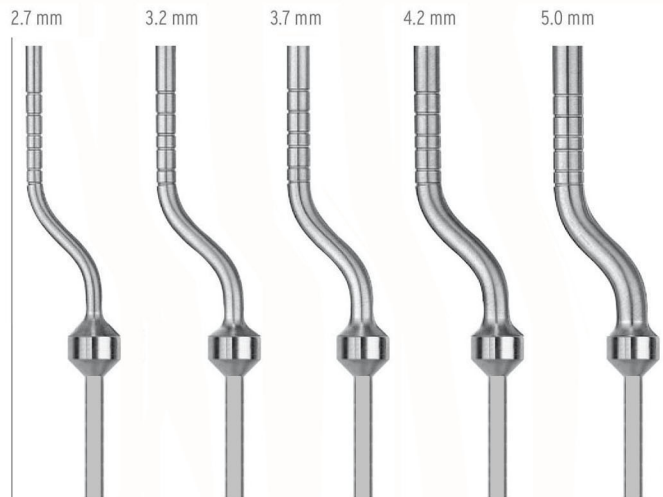

IPOA2.7 2325   IPOA3.2 2326   IPOA3.7 2327   IPOA4.2 2328   IPOA5.0 2329

# IMPLANTOLOGY

## CALIPERS & BONE GRAFTING SYRINGES

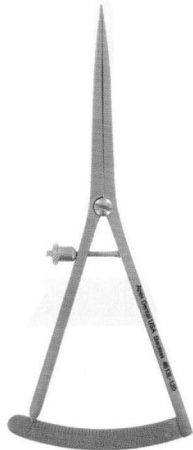

CASTROVIEJO  
STR 17CM

**ICVCS17**  
2382



Castroviejo  
Calipers  
Straight  
0-40mm  
18cm/7"

**ICVCS18**  
2384



Castroviejo  
Calipers  
Angled  
0-40mm  
18cm/7"

**ICVCCA18**  
2386



Bone Grafting  
Syringe  
7mm

**IBGS7**  
2396

- 2386-1.0mm **IBGS1**  
2389
- 2387-2.0mm **IBGS2**  
2390
- 2388-2.5mm **IBGS2.5**  
2391
- 2389-3.0mm **IBGS3**  
2392
- 2390-4.0mm **IBGS4**  
2393
- 2391-5.0mm **IBGS5**  
2394
- 2392-6.0mm **IBGS6**  
2395

NOTE: Also available in  
1mm, 2mm, 2.5mm, 3mm, 4m, 5mm and 6mm



Weiss Modified  
Castroviejo  
Calipers  
0-40mm  
17cm/6 3/4"

**IWMCV17**  
2383

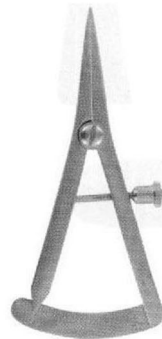

CASTROVIEJO  
STR 8.5cm  
ICVC-ST8.5cm

**ICVCS8.5**  
2385

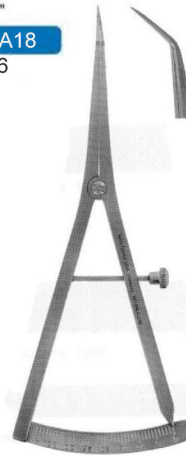

CASTROVIEJO  
CVD 17cm  
ICVC-CV17cm

**ICVCA17**  
2387



Cortical  
Bone Clamp

**ICBC**  
2388





Bone Grafting 1 Ring Style Syringe  
Straight, 3.75mm

**IBGS1RSS3.75**  
2400



Bone Grafting 1 Ring Style Syringe  
Straight, 50.0mm

**IBGS1RSS5.0**  
2402



Bone Grafting 1 Ring Style Syringe  
Curved, 3.75mm

**IBGS1RSC3.75**  
2401



Bone Grafting 1 Ring style Syringe  
Curved, 5.0mm

**IBGS1RSC5.0**  
2403



Ridge Mapping, Bone Width 0.25mm  
Both Side Reading, 14cm

**RMBC14**  
2410



Caliper Double sided Reading  
Scissors Style

**ICDSS**  
2411



Sliding Implant Caliper, 94mm  
1.5mm Tip diameter

**ISIC94**  
2412



Stainless Steel Ruler  
15cm/6"

**SSR**  
2413



Bone collector Chise, Straight

**IBCC**  
2415



Bone Collector Blade, Straight

**IBCBS**  
2416



Bone Collector Blade

**IBCBS**  
2418

**IBCCC**  
2417

Bone Collector Chisel, Curved

# IMPLANTOLOGY

## ENDO FORCEPS, BONE CRUSHERS & MALLETS

Micro Surgery Endo Forceps, 95mm

IMSEF95  
2419

Micro Surgery Endo forceps, 110mm

IMSEF110  
2420

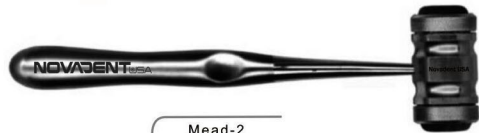

Mead-2  
Mallet

IM2M  
2421



Bone Crusher

IBC  
2424



130g  
Mallet

I130M  
2422



235g  
Mallet

I235M  
2423



Bone Morseriser

IBM  
2425